

Similar Figures

Each pair of figures is similar. Find the missing side.

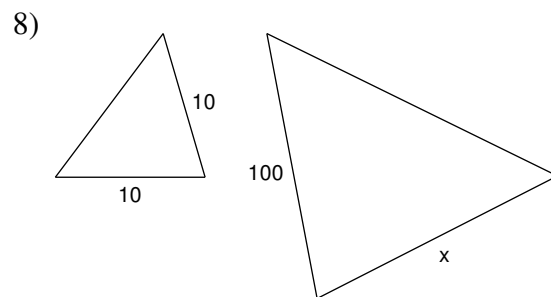

9)

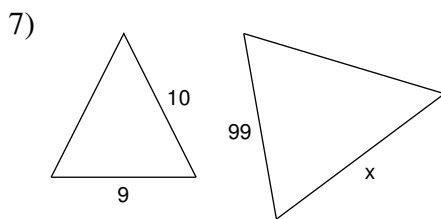
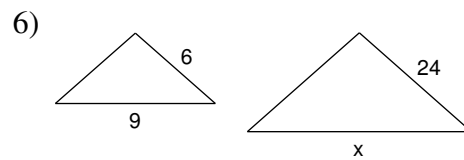
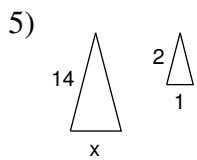
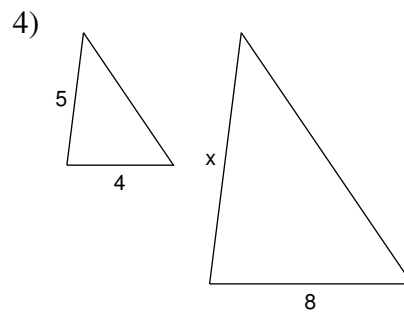
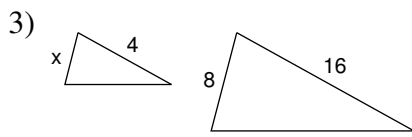
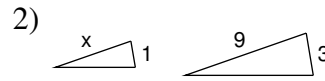
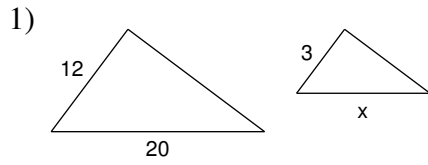
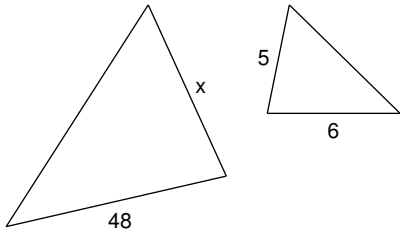

10)

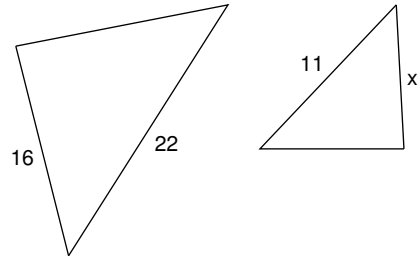

11)

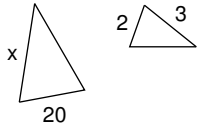

12)

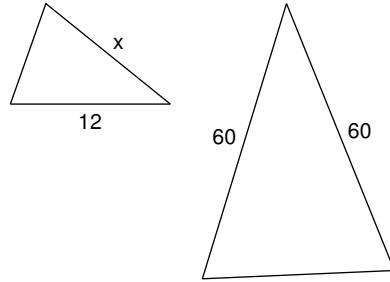

13)

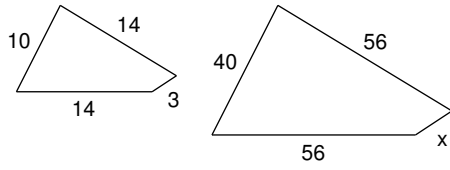

14)

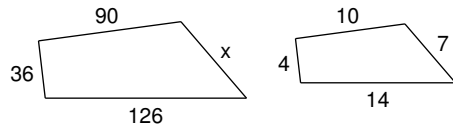

15)

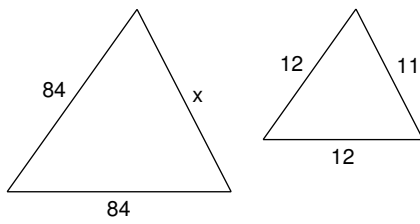

16)

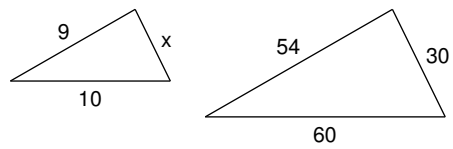

17)

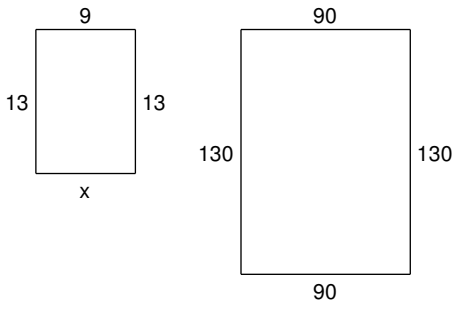

18)

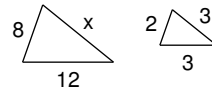

19)

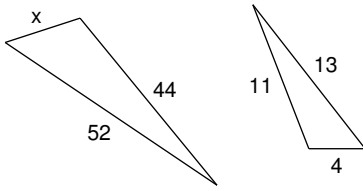

20)

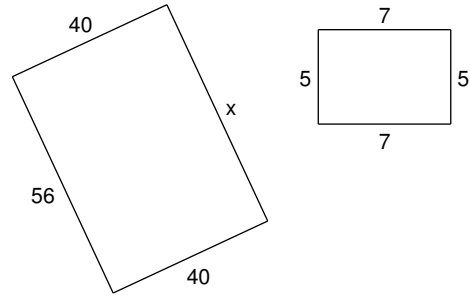

21)

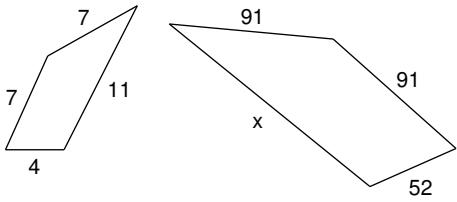

22)

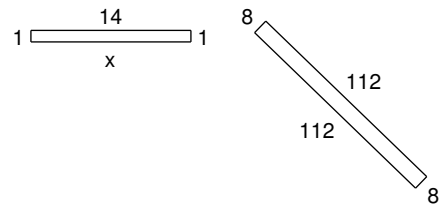

23)

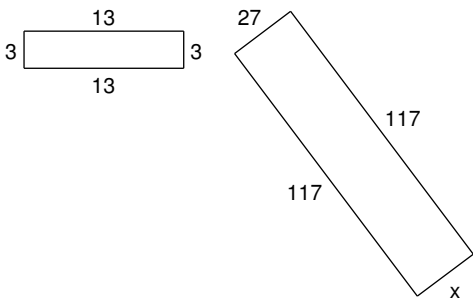

24)

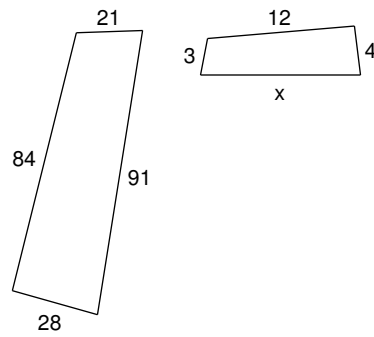

Similar Figures

Each pair of figures is similar. Find the missing side.

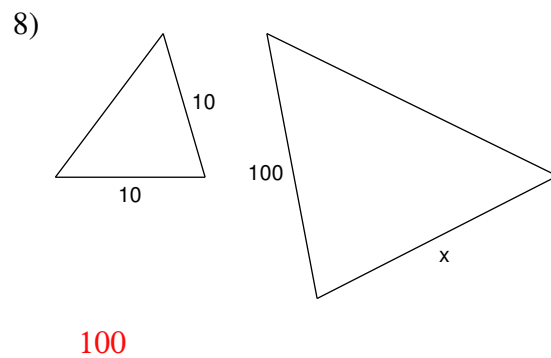
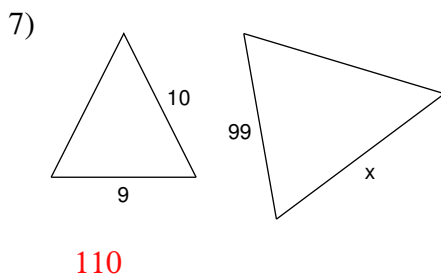
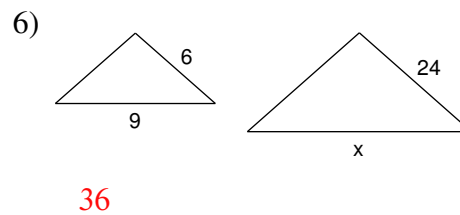
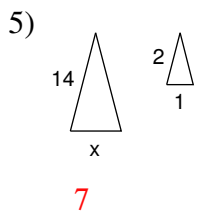
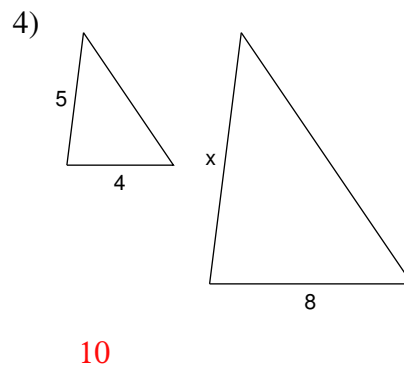
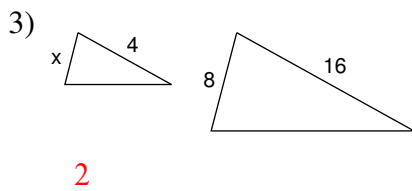
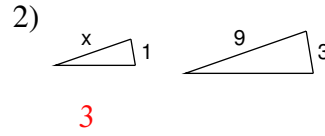
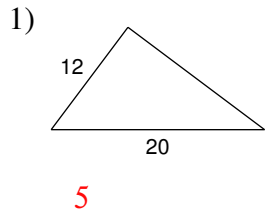

9)

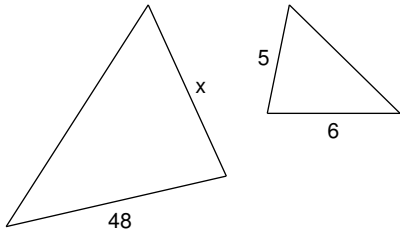

40

10)

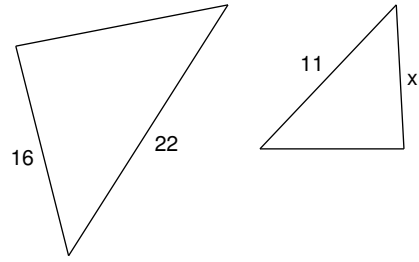

8

11)

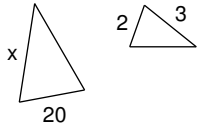

30

12)

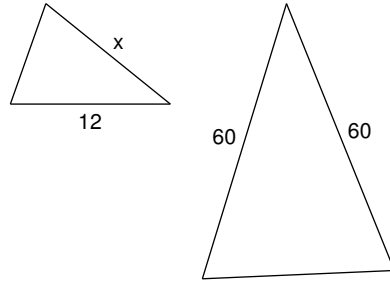

12

13)

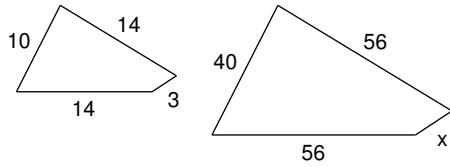

12

14)

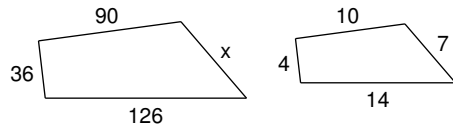

63

15)

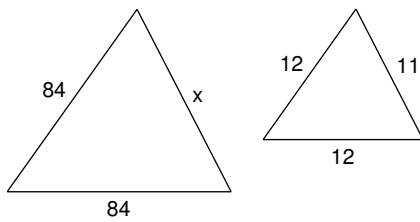

77

16)

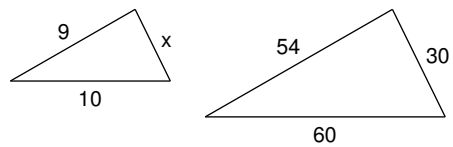

5

17)

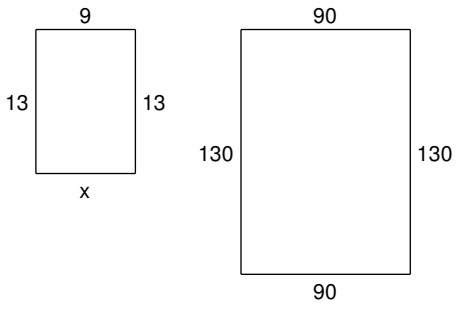

9

18)

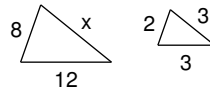

12

19)

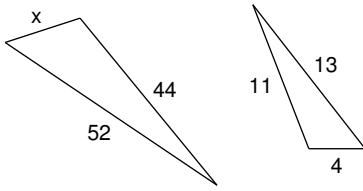

16

20)

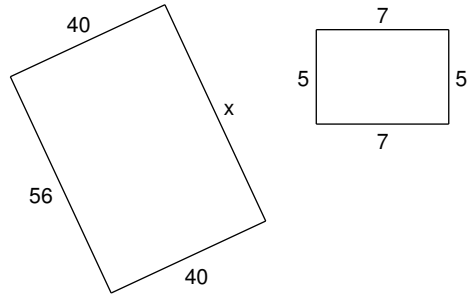

56

21)

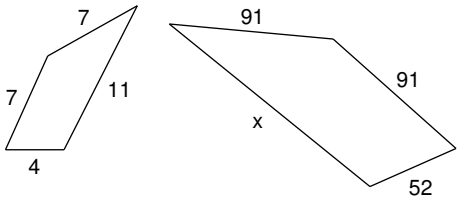

143

22)

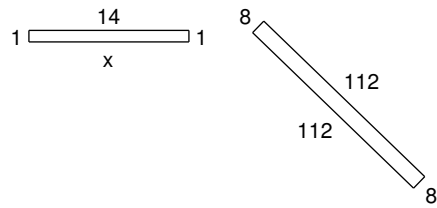

14

23)

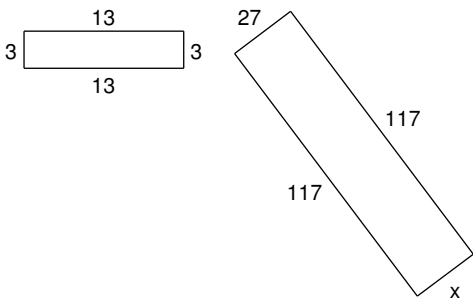

27

24)

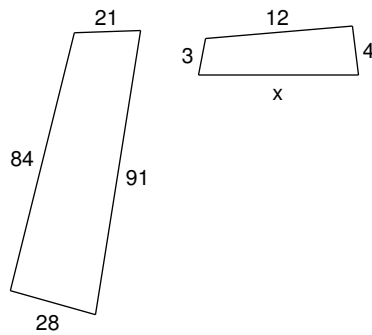

13